

Customer Termination Box 3 (CTB3)



Enables blown fibre and fixed cable access to the customer premises

The Heatronic CTB (CSP) enables Blown Fibre and fixed cable access to the customer premises. Compatible with all standard deployment methods including Blown Fibre Drop Tube and fixed cable from overhead, external duct or internal duct.

The unique two layer management system provides separate work areas for both Network and Access. Each space can accommodate Splice, Patch and Storage.

To ensure the product is presented well on customer properties, the CTB interfaces directly with our standard capping and hardware.

Features

- 30mm bend radius
- Input cable range 3-7mm
- Output cable range 3-7mm
- Accepts ABF, OH Drop, UG Drop
- Multi-access locations
- Exit through the base or rear of the enclosure
- Tamper screw option
- 8x Splice, 4x Patch
- UV Stable



Suitable for SDU solutions

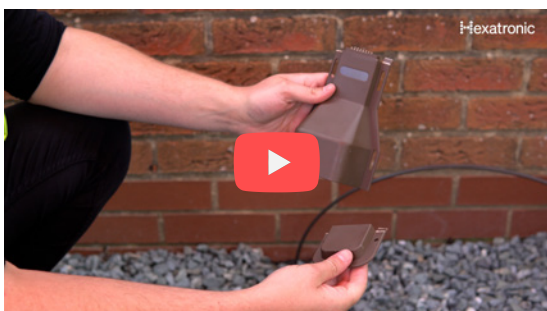

[Click to view our CTB3 and Capping video](#)

Available in colours



Specifications

Ports	2 cable, 4 patch
Cable Diameter	3-8 mm
Dimensions	140 x 190 x 45 mm
Splice Capacity	8
Patch Capacity	4
Material	PP, ABS or HIPS

Stackable Management (tool-less)

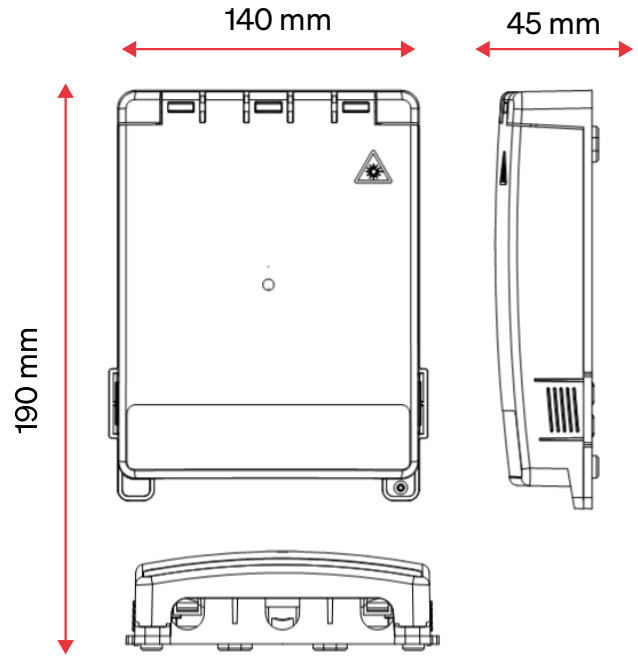
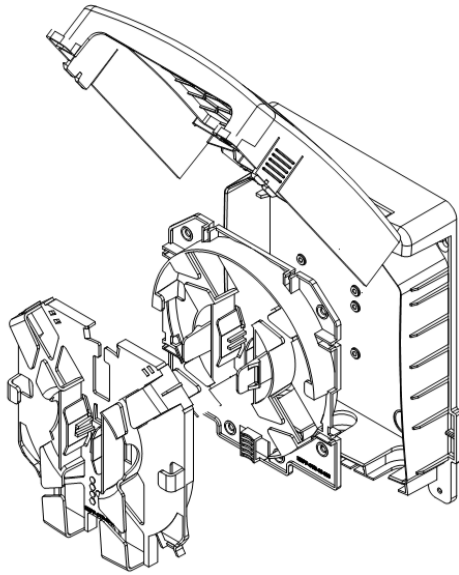

Top Module

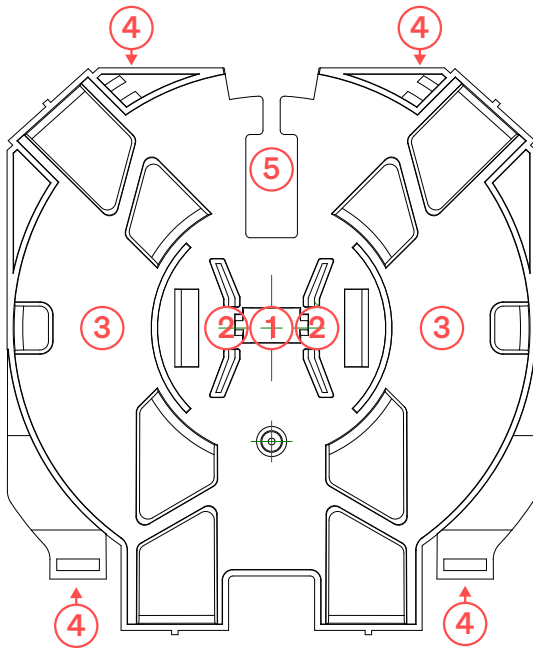

Bottom Module

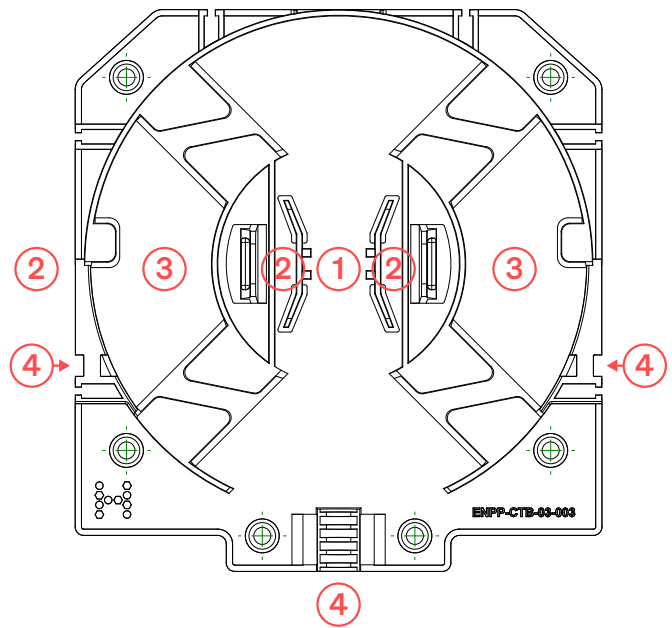

1. Adaptor
2. Splice Holder
3. Fibre Loop Storage
4. Cable Tie Point
5. Cross Module Access Channel

Part Numbers

Description

FCLC-CTB-03-ULD-001-BN

Customer Termination Box 3 Unloaded - Brown

FCLC-CTB-03-ULD-001-BK

Customer Termination Box 3 Unloaded - Black

FCLC-CTB-03-ULD-001-GY

Customer Termination Box 3 Unloaded - Grey

CTB3 Interfaces directly with our capping and hardware

Combine the Customer Termination Box 3 directly with the Hexatronic External Capping hardware; a system designed to protect cables and microducts at the customer demarcation point. Providing a swift and trouble-free install, whilst maintaining a presentable, discreet and modernised look.

- Includes capping, base and top
- Ability to alter height of capping to suit premises
- Available in a range of colours to match your CTB3
- Provides cable protection to customers' premises
- Impact-resistant

Available in colours

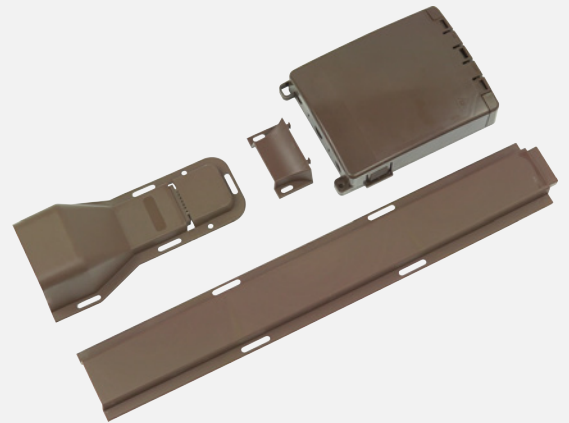

CTB3
FCLC-CTB-03

CTB3 Adaptor
FOAM-SQ-CAP-CT3

Directly interfaces
with the External
Capping

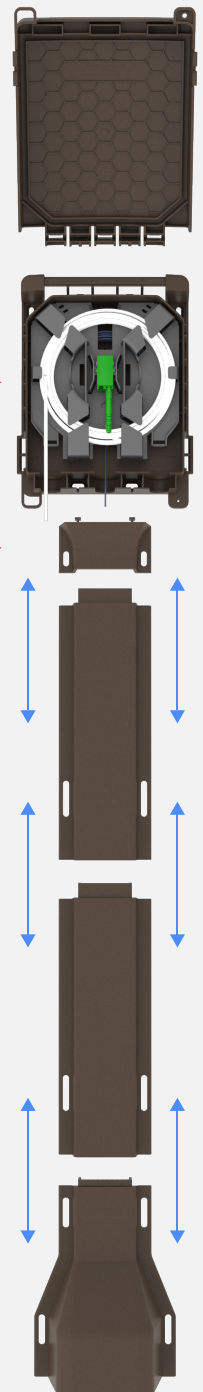
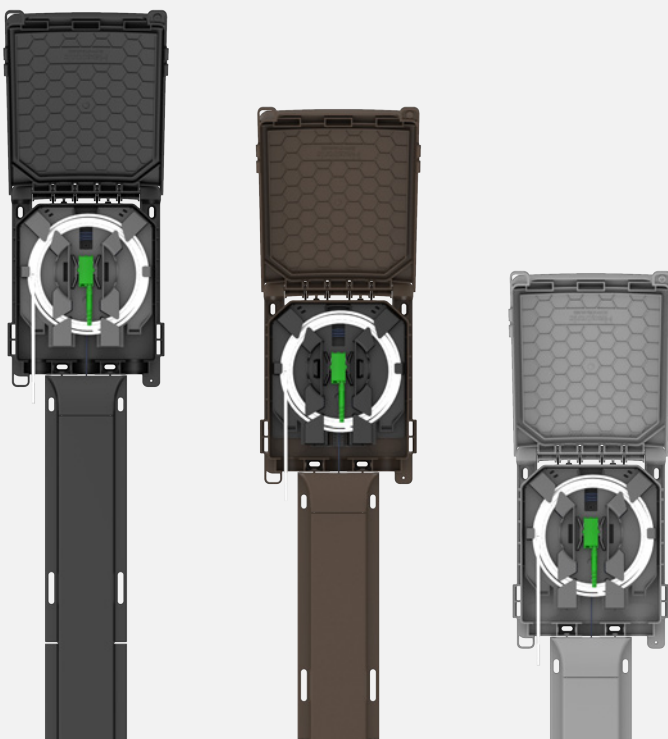

Hexatronic FTTH Application Example

Click a product to read more information!



Subscriber Wallbox
FCLC-DIS-ICB



CTB3
FCLC-CTB-03



Discreet NanoClip™
ENFF-DIS-CLIP-xMM-MTL-xx

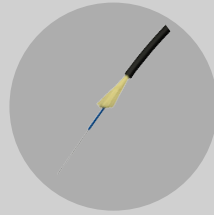

External Subscriber Cable
FCAT-CxX-SM



Aerial Subscriber Node
FCLW-ASN-B-P00-UNL

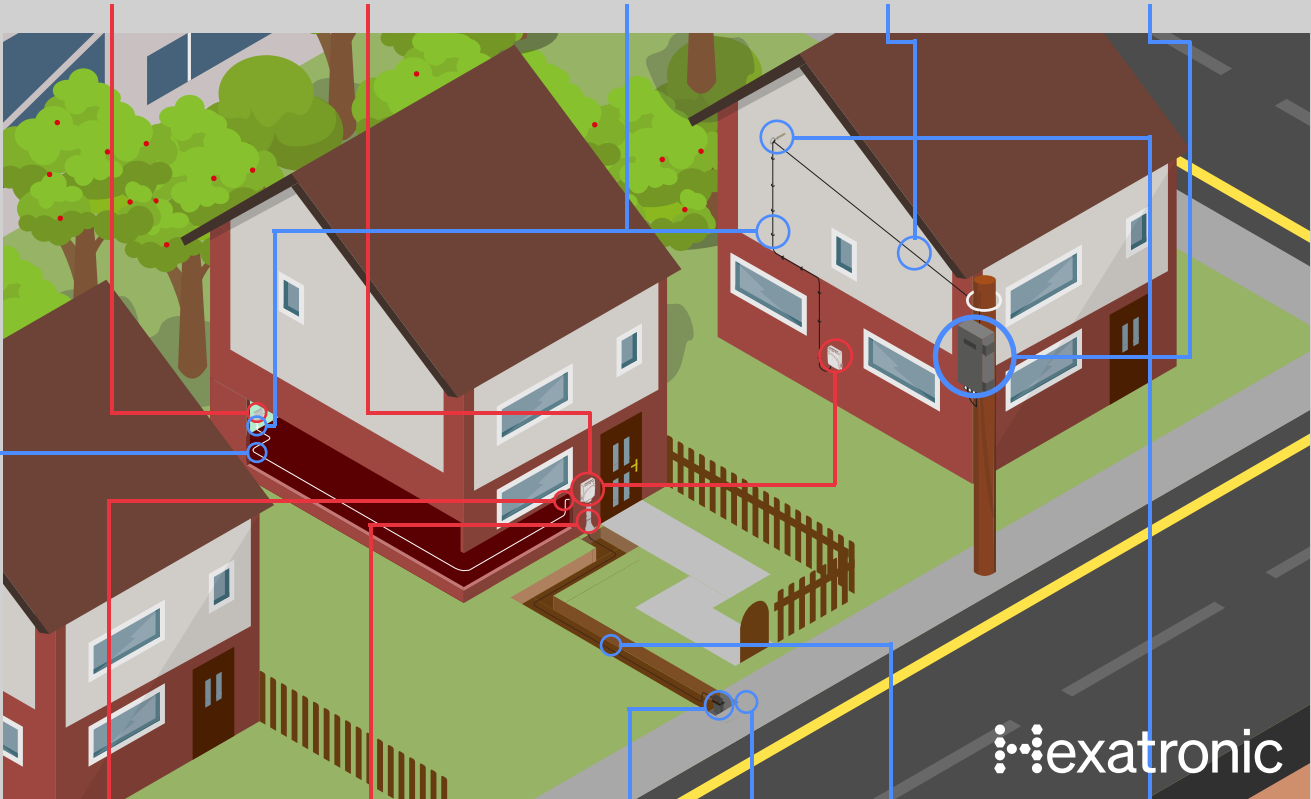

Customer Lead-In
FOAM-EXT-CLI-xx

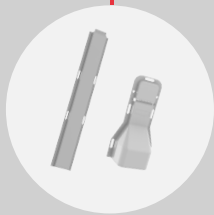

External Capping
FOAM-SQ-CAP-500-xx

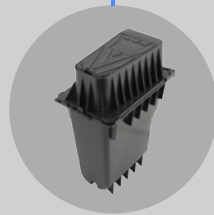

Access Chamber
HSBX-TBY-BOX-SQ21



Direct Buried Microduct
MPB30284+



Eyebolt
ENFF-EX-EYE-BOLT-8/10MM

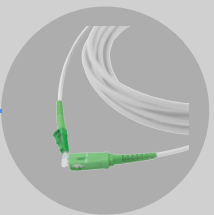

Indoor Subscriber Cable
FTAC-SM7L45-xxx-xxx

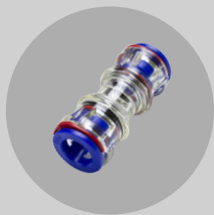

Microduct Connector
FDCX-HMPB30601

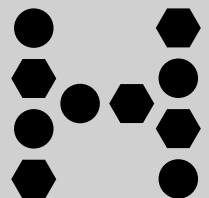

Flexibility

Designed to serve any network topology.

Protection

Built to withstand harsh environmental conditions including dust, moisture and UV.

Performance

Controlled bend radius which reduces the risk of attenuation caused by tight bends.

Easy installation

Mounts on a wall or other flat surface with minimal tools.

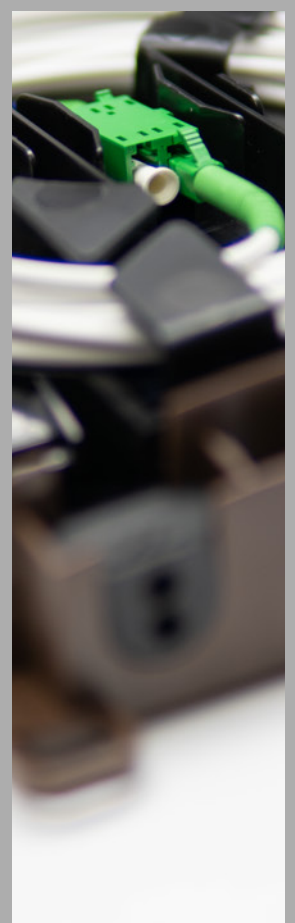
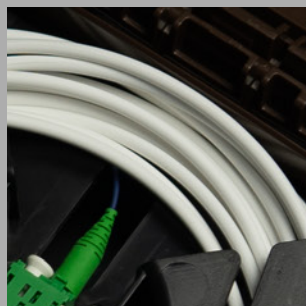

A lasting link to the future

hexatronic.com/uk

Hexatronic creates sustainable networks worldwide. We collaborate with customers on four continents – from telecom operators to network owners – and offer leading, high-class fiber solutions for all conceivable areas of use.

